

# GLPAC System



The GLPAC SpaceBuilder system is ideal for medium-sized spaces that require additional options such as expansion modules for more load types, touch screens, additional sensors, and shade and AV integration.

SpaceBuilder allows you to specify all the necessary features and operations for an autonomous lighting control system specifically designed for the needs of your space. Start by selecting the load types and accessories and finish by defining how each interface should function to control lighting levels, vacancy sensing, daylight harvesting, shades, and AV.

## System Components

### GLPAC

Available in 4 or 8 zone versions to control both switching and 0-10V dimming loads. Options include regular and emergency versions as well as a split 4 regular and 4 emergency zone panel. All GLPAC systems can be expanded to easily add more zones of lighting.

### Keypads

Up to 4 keypads can be added to a GLPAC space. Refer to page 4 for standard sequence of operations to specify the button operations and standard engravings.

### Occupancy Sensors

Up to 4 dual technology occupancy sensors can be added to each GLPAC space for either occupancy or vacancy sensing. Each sensor offers coverage for spaces up to 2,000 square feet. Sensor coverage varies based on type, see detail at end of this worksheet. Sensor defaults to vacancy operation unless noted as occupancy operation in the space part number.

### Daylight Sensors

Up to 4 daylight sensors can be added to each GLPAC space for daylight harvesting control. Open-loop and closed-loop options are available.

## Options

### Touch Screens

An optional 7" color touch screen can be added to each to provide the user with full scene control, dynamic load control, and schedule adjustments.

### Loads

Any GLPAC system can be expanded to include additional loads for 2-wire phase, DMX, or switched plug loads.

### AV Integration

The GLPAC system can easily integrate with AV systems by adding a serial control module. If this option is selected, Crestron will also supply prepackaged code for the AV contractor to connect the systems.

### Shade Integration

Integrate with Crestron and other shading solution systems. Control for up to 4 local shade motors can be included with each GLPAC system.

### Networking

Any Crestron SpaceBuilder system can be networked to provide centralized monitoring, management, and master control. This includes direct integration with BMS and reporting, alerts, global time clock management, maintenance, and automation via Crestron Fusion®.

GLPAC\_ \_\_\_\_\_ - \_\_\_\_\_ KP- \_\_\_\_\_ KP- \_\_\_\_\_ KP- \_\_\_\_\_ KP- \_\_\_\_\_ - \_\_\_\_\_ - \_\_\_\_\_ - \_\_\_\_\_ - \_\_\_\_\_  
 \_\_\_\_\_ - \_\_\_\_\_ - \_\_\_\_\_ - \_\_\_\_\_ - \_\_\_\_\_ - \_\_\_\_\_ - \_\_\_\_\_ - \_\_\_\_\_

Date: \_\_\_\_\_ Project: \_\_\_\_\_  
 Quantity: \_\_\_\_\_ Space Name: \_\_\_\_\_  
 Space Number(s): \_\_\_\_\_

### GLPAC SpaceBuilder Load Schedule

Zone #	Zone Description	Fixture Tag	Circuit #	Voltage	Load Type	Emergency / Life Safety	Dim (Y/N)	Fixture Watts	Quantity	Total Watts
Example	Pendants	a	HZ-1	277 VAC	0-10V	None	Yes	50W	4	200W
1										
2										
3										
4										
5										
6										
7										
8										
9										
10										
11										
12										
13										
14										
15										
16										
Add a Zone 1										
Add a Zone 2										
Add a Zone 3										
Add a Zone 4										

277 VAC 120 VAC	Switched 0-10V 4-Wire Dimmed Universal Phase Dimmed DMX	None Partial Zone Complete Zone	Yes No
--------------------	--	---------------------------------------	-----------

GLPAC\_ \_\_\_\_\_ - \_\_\_\_\_ KP- \_\_\_\_\_ KP- \_\_\_\_\_ KP- \_\_\_\_\_ KP- \_\_\_\_\_ - \_\_\_\_\_ - \_\_\_\_\_ - \_\_\_\_\_ - \_\_\_\_\_  
 \_\_\_\_\_ - \_\_\_\_\_ - \_\_\_\_\_ - \_\_\_\_\_ - \_\_\_\_\_ - \_\_\_\_\_ - \_\_\_\_\_ - \_\_\_\_\_

Date: \_\_\_\_\_ Project: \_\_\_\_\_  
 Quantity: \_\_\_\_\_ Space Name: \_\_\_\_\_  
 Space Number(s): \_\_\_\_\_

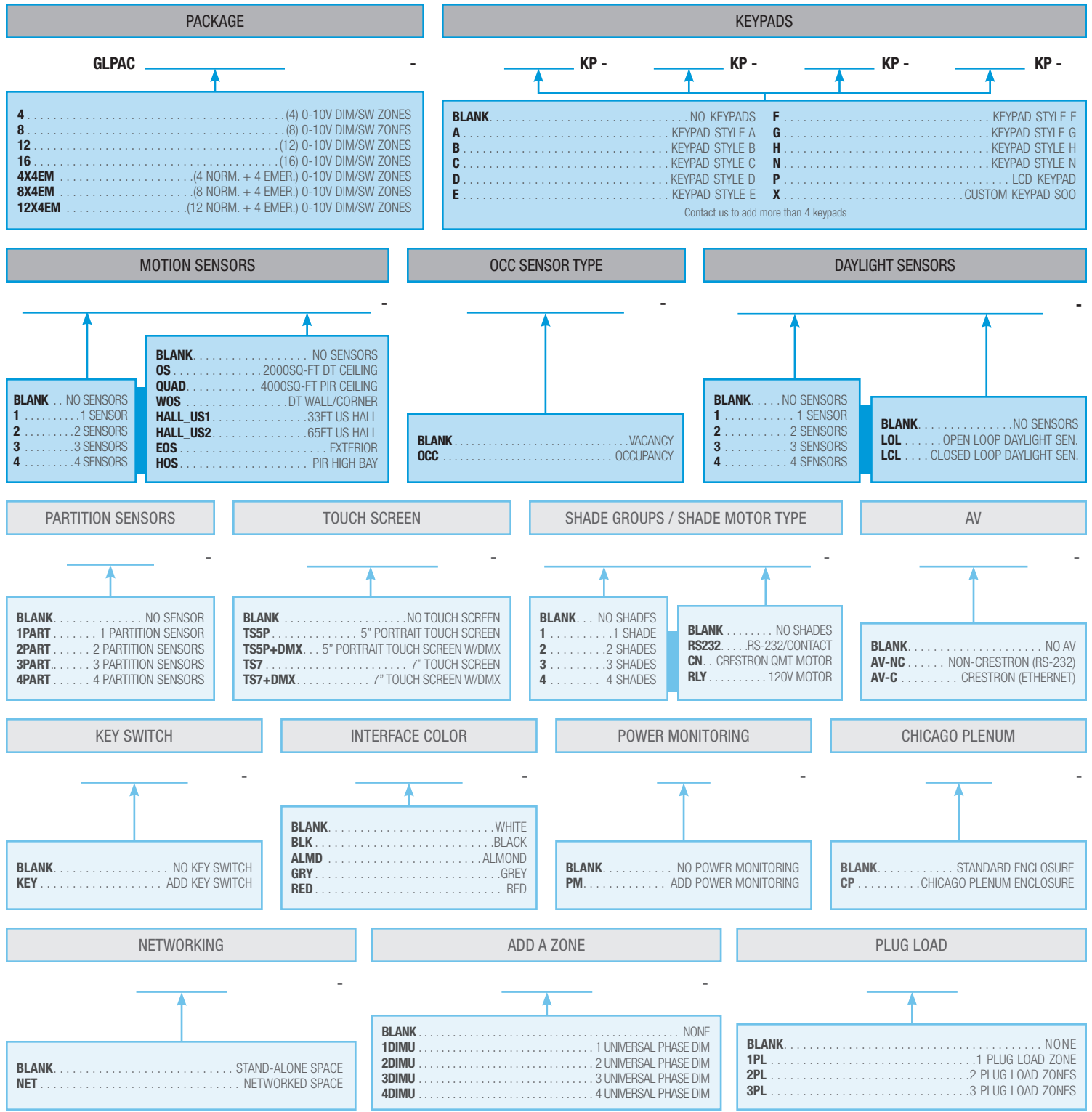

Example: GLPAC4 - AKP - PKP - 2QUAD - 1LOL - 2PART - TS5P - NET - 2PL

GLPAC \_\_\_\_\_ - \_\_\_\_\_ KP- \_\_\_\_\_ KP- \_\_\_\_\_ KP- \_\_\_\_\_ KP- \_\_\_\_\_

Date: \_\_\_\_\_ Project: \_\_\_\_\_  
 Quantity: \_\_\_\_\_ Space Name: \_\_\_\_\_  
 Space Number(s): \_\_\_\_\_

GLPAC SpaceBuilder Schematic Riser

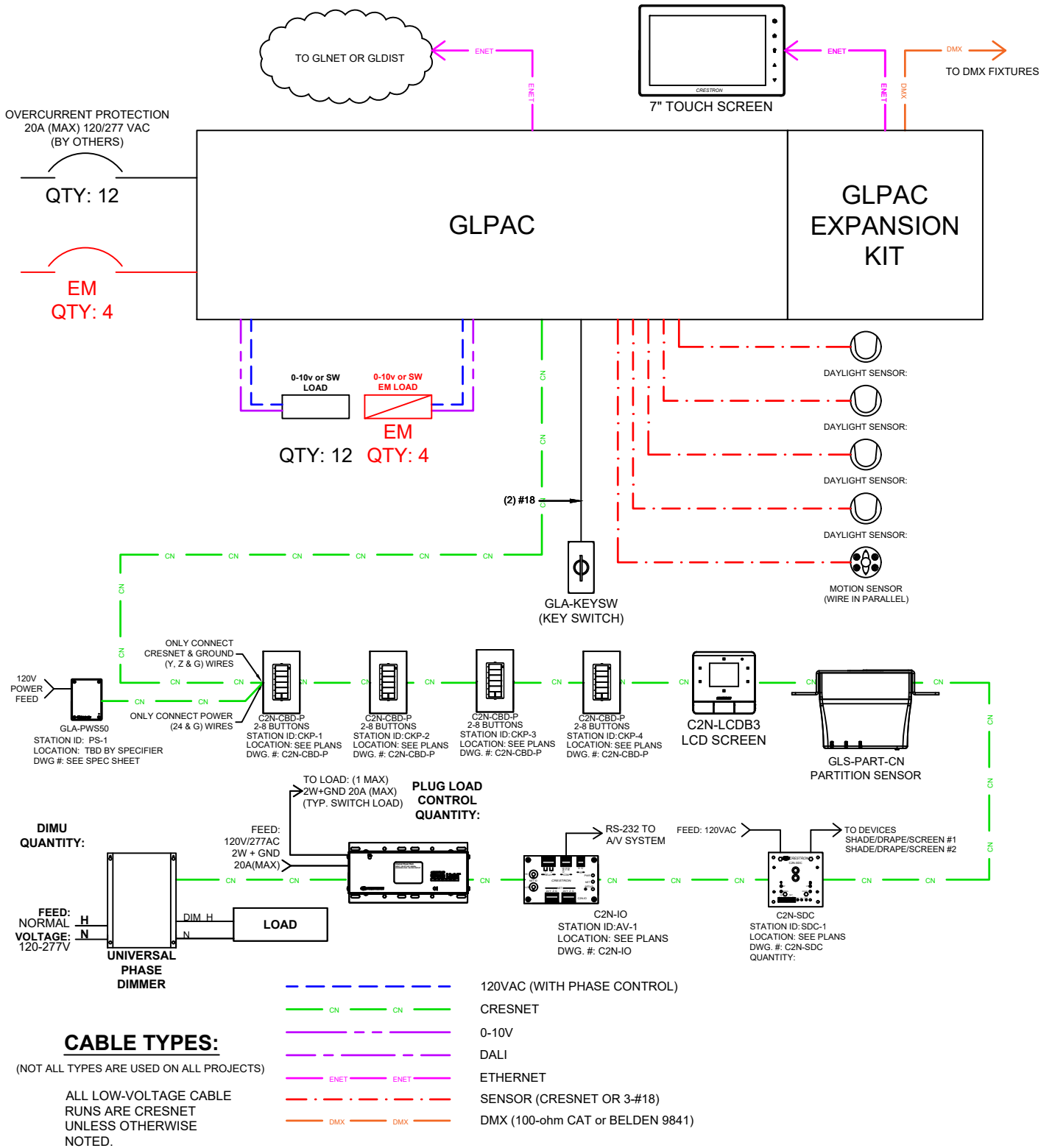

GLPAC \_\_\_\_\_ - \_\_\_\_\_ KP- \_\_\_\_\_ KP- \_\_\_\_\_ KP- \_\_\_\_\_ KP- \_\_\_\_\_ - \_\_\_\_\_ - \_\_\_\_\_ - \_\_\_\_\_ - \_\_\_\_\_ - \_\_\_\_\_

Date: \_\_\_\_\_ Project: \_\_\_\_\_  
 Quantity: \_\_\_\_\_ Space Name: \_\_\_\_\_  
 Space Number(s): \_\_\_\_\_

## GLPAC SpaceBuilder Sequence of Operations

### KEYPAD TYPE A

**Typical Applications**

Office, Restroom, Storage/Utility Room, Corridor, Basic Classroom

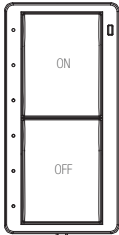

**Button 1 Functionality: ON**

- > Turn all lights on and enable daylight harvesting
- > If daylight sensor is not present, lights will turn on to 100%

**Button 2 Functionality: OFF**

- > Turn all lights off to 0% and disable daylight harvesting

### KEYPAD TYPE B

**Typical Applications**

Office, Conference Room, Classroom, Library

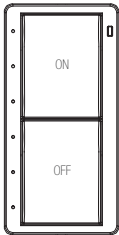

**Button 1 Functionality: ON**

- > Turn all lights on and enable daylight harvesting
- > If daylight sensor is not present, lights will turn on to 100%
- > Press and hold will raise all dimmable lighting

**Button 2 Functionality: OFF**

- > Turn all lights off to 0% and disable daylight harvesting
- > Press and hold will lower all dimmable lighting

### KEYPAD TYPE C

**Typical Applications**

Office, Conference Room, Classroom, Library

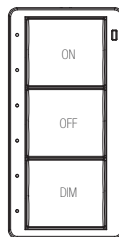

**Button 1 Functionality: ON**

- > Turn all lights on and enable daylight harvesting
- > If daylight sensor is not present, lights will turn on to 100%

**Button 2 Functionality: OFF**

- > Turn all lights off to 0% and disable daylight harvesting

**Button 3 Functionality: DIM**

- > Toggle to dim load up and down

### KEYPAD TYPE D

**Typical Applications**

Office, Conference Room, Classroom, Library

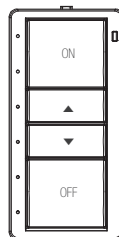

**Button 1 Functionality: ON**

- > Turn all lights on and enable daylight harvesting
- > If daylight sensor is not present, lights will turn on to 100%

**Button 2 Functionality: ▲**

- > Dim lights up

**Button 3 Functionality: ▼**

- > Dim lights down

**Button 4 Functionality: OFF**

- > Turn all lights off to 0% and disable daylight harvesting

### KEYPAD TYPE E

**Typical Applications**

Office, Conference Room, Cafeteria, Library, Multipurpose Room, Lobby, Ballroom

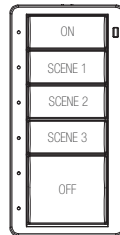

**Button 1 Functionality: ON**

- > Turn all lights on and enable daylight harvesting
- > If daylight sensor is not present, lights will turn on to 100%

**Button 2 Functionality: SCENE 1**

- > Recalls scene 1 settings with feedback

**Button 3 Functionality: SCENE 2**

- > Recalls scene 2 settings with feedback

**Button 4 Functionality: SCENE 3**

- > Recalls scene 3 settings with feedback

**Button 5 Functionality: OFF**

- > Turn all lights off to 0% and disable daylight harvesting

### KEYPAD TYPE F

**Typical Applications**

Office, Conference Room, Classroom, Library

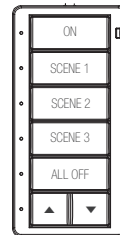

**Button 1 Functionality: ALL ON**

- > Turn all lights on and enable daylight harvesting
- > If daylight sensor is not present, lights will turn on to 100%

**Button 2 Functionality: SCENE 1**

- > Recalls scene 1 settings with feedback

**Button 3 Functionality: SCENE 2**

- > Recalls scene 2 settings with feedback

**Button 4 Functionality: SCENE 3**

- > Recalls scene 3 settings with feedback

**Button 5 Functionality: ALL OFF**

- > Turn all lights off to 0% and disable daylight harvesting

**Button 6 Functionality: ▲**

- > Dim lights up

**Button 7 Functionality: ▼**

- > Dim lights down

Continued on page 6

GLPAC \_\_\_\_\_ - \_\_\_\_\_ KP- \_\_\_\_\_ KP- \_\_\_\_\_ KP- \_\_\_\_\_ KP- \_\_\_\_\_ - \_\_\_\_\_ - \_\_\_\_\_ - \_\_\_\_\_ - \_\_\_\_\_

Date: \_\_\_\_\_ Project: \_\_\_\_\_  
 Quantity: \_\_\_\_\_ Space Name: \_\_\_\_\_  
 Space Number(s): \_\_\_\_\_

## GLPAC SpaceBuilder Sequence of Operations, Continued

**KEYPAD TYPE G** *Typical Applications: Office, Conference Room, Classroom, Library, Applications where dimming and switching both exist and need separate control*



- Button 1 Functionality: DIMMING ON/OFF**
  - Toggle dimmable zones on or off with feedback if any lights are on
  - Toggle to turn daylight harvesting on or off
  - If daylight sensor is not present, lights will turn on to 100%
- Button 2 Functionality: ▲**
  - Dim lights up
- Button 3 Functionality: ▼**
  - Dim lights down
- Button 4 Functionality: SWITCHING ON/OFF**
  - Toggle dimmable zones on or off with feedback if any lights are on

**KEYPAD TYPE H** *Typical Applications: Office, Conference Room, Classroom, Library, Applications where shades control is needed*

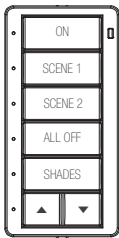

- Button 1 Functionality: ALL ON**
  - Turn all lights on and enable daylight harvesting
  - If daylight sensor is not present, lights will turn on to 100%
- Button 2 Functionality: SCENE 1**
  - Recalls scene 1 settings with feedback
- Button 3 Functionality: SCENE 2**
  - Recalls scene 2 settings with feedback
- Button 4 Functionality: ALL OFF**
  - Turn all lights off to 0% and disable daylight harvesting
- Button 5 Functionality: SHADES**
  - Activates up and down arrows to control shades.
  - After 5 seconds of inactivity, up and down arrows revert back to dimming lights up and down.
- Button 6 Functionality: ▲**
  - Dim lights up (shades up when SHADES button is active)
- Button 7 Functionality: ▼**
  - Dim lights down (shades down when SHADES button is active)

**KEYPAD TYPE N** *Typical Applications: Office, Conference Room, Classroom, Library, Applications where shades control is needed*

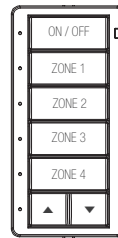

- Button 1 Functionality: ALL ON / OFF**
  - Toggle all lights on and off
- Button 2 Functionality: ZONE 1**
  - Zone 1 on, press and hold for off
- Button 3 Functionality: ZONE 2**
  - Zone 2 on, press and hold for off
- Button 4 Functionality: ZONE 3**
  - Zone 3 on, press and hold for off
- Button 5 Functionality: ZONE 4**
  - Zone 4 on, press and hold for off
- Button 6 Functionality: ▲**
  - Dim last touched zone up
- Button 7 Functionality: ▼**
  - Dim last touched zone down

**LCD KEYPAD TYPE P** *Typical Applications: Conference Room, Cafeteria, Library, Multipurpose Room, Lobby, Ballroom*



Color LCD keypad gives control of lighting scenes 1, 2 and OFF.

**KEYPAD TYPE X** *Typical Applications: All applications needing a custom keypad button configuration and functionality*

Custom Keypad S00

### Note

By selecting keypad types, the SpaceBuilder system will be programmed, packaged, and shipped from the factory as an operable turnkey lighting control solution. Additional on-site support may be required for scene or sensor calibration.

GLPAC\_ \_\_\_\_\_ - \_\_\_\_\_ KP- \_\_\_\_\_ KP- \_\_\_\_\_ KP- \_\_\_\_\_ KP- \_\_\_\_\_ - \_\_\_\_\_ - \_\_\_\_\_ - \_\_\_\_\_ - \_\_\_\_\_

Date: \_\_\_\_\_ Project: \_\_\_\_\_  
 Quantity: \_\_\_\_\_ Space Name: \_\_\_\_\_  
 Space Number(s): \_\_\_\_\_

## GLPAC Specifications

### LOAD RATINGS

#### Dimmer Channels

GLPAC-DIMFLV4(-PM): 4  
GLPAC-DIMFLV8(-PM): 8

#### Per Channel

16 Amps @ 100 to 277 Volts AC, 50/60 Hz

#### Dim Load Types

0-10 Volt fluorescent ballast (4-wire); 0-10V LED drivers;  
60 mA max current sink

#### Switch Load Types

Fluorescent Ballast, Incandescent, Magnetic Low-Voltage,  
Electronic Low-Voltage, Neon/Cold Cathode, High-Intensity  
Discharge, LED, Motor

#### Relay Lifetime

Resistive rating: 100,000 on/off operations, 50A @ 277 VAC  
General rating: 50,000 on/off operations, 16A @ 120/277 VAC

### ENCLOSURE

Surface mount metal box enclosure, suitable for  
mounting in plenum airspace

### ENVIRONMENTAL

#### Temperature

32° to 104°F (0° to 40°C)

#### Humidity

10% to 90% RH (non-condensing)

### DIMENSIONS

#### Height

12.13 in (308 mm)

#### Width

14.13 in (359 mm)

#### Depth

4.06 in (103 mm)

### ELECTRICAL REGULATORY CERTIFICATIONS

Relays tested and certified for Electronic Ballasts according  
to UL508, Section 41 (Endurance Test) and Section 61C  
(Electronic Ballasts)

IEC60669-2-1, Section 19.102 (Contact mechanisms  
incorporated in electronic switches, intended for fluorescent  
lamp circuits or other capacitive loads)

CEC Title 24 2013 Compliant



- Up to 8 channels of 0-10 Volt fluorescent and LED dimming or switching
- Works in 100 to 277 VAC systems
- 16-Amp load rating per channel
- Built-in Control System with Cresnet® and Ethernet port
- Programmable astronomical time clock for scheduled events
- Preloaded program for quick setup
- Optional real-time power monitoring per channel
- Supports keypad control, occupancy sensing, and daylight harvesting
- Positive air gap at each output
- Phase-independent channels
- Local controls for setup, testing and verification
- Local and remote override capability
- Non-volatile power failure memory
- High-speed Ethernet LAN port

### Products in this system can include:

- GLS-ODT-C-NS: 2000 Square Foot Dual Technology Ceiling Mount Occupancy Sensor
- GLA-IR-QUATTRO-HD-COM1-24: 4000 sq-ft interior ceiling motion sensor
- GLA-DT-CM-COM1-24: Dual technology corner mount motion sensor
- GLA-US-ONEWAY-COM1-24: Ultrasonic 35ft corridor motion sensor
- GLA-US-HALLWAY-COM1-24: Ultrasonic 65ft corridor motion sensor
- GLA-IS-360: High bay motion sensor
- GLA-HBS-300: Exterior motion sensor
- GLS-LCL: Closed loop daylight sensor
- GLS-LOL: Open Loop Daylight Sensor
- C2N-IO: Serial RS-232 interface
- TSW-760: 7" Touch Screen
- C2N-CBD-P: Keypad
- C2N-LCDB3: LCD Keypad
- TSW-560P: 5" Portrait Touch Screen
- GLA-KEYSW-MAINTAIN: Keyed switch

For technical specifications on all other products in this system,  
please visit [www.crestronlighting.com](http://www.crestronlighting.com)

For more information or to access digital specification forms for all Crestron  
SpaceBuilder systems, visit [www.crestronspacebuilder.com](http://www.crestronspacebuilder.com) or call **855-644-7643**

### Notes:

GLPAC \_ \_ \_ \_ - \_ \_ \_ KP- \_ \_ \_ KP- \_ \_ \_ KP- \_ \_ \_ KP- \_ \_ \_ - \_ \_ - \_ \_ \_ - \_ \_ - \_ \_ \_ - \_ \_ - \_ \_ \_

Date: \_\_\_\_\_ Project: \_\_\_\_\_  
Quantity: \_\_\_\_\_ Space Name: \_\_\_\_\_  
Space Number(s): \_\_\_\_\_